

MDG

User Guide



Me1, Fog Generator

(Revision A/b, April 2015, © MDG Fog Generators Ltd)



Les Générateurs de Brouillard MDG Ltée / MDG Fog Generators Ltd
10301 avenue Pelletier, Montréal, Québec, Canada H1H 3R2
Tel. 514-272-6040 / 800-663-3020 - Fax 514-722-3229
www.mdgfog.com e-mail : info@mdgfog.com



Intentionally left blank

Table of content

Section	Page
Table of content	3
User Guide	4
How to read this User Guide	4
Qualified Personnel	5
Need a little Help?	5
Copyright Notice	5
Basic description	6
Installing the Me1	8
Working with the Me1	9
The Keyboard	10
LCD Saver	10
Menu Tree	11
Operating instructions	14
DMX Control	17
Bootloader	18
RDM Control	18
Fog Fluid	20
Filling the Fluid Reservoir	20
Troubleshooting	21
Accessories	24
Flight Case	24
Portability option	24
Cable Requirements	25
Connection to the main	25
DMX 512 connection	25
Technical specifications	26
Dimensions	27
Warranty	29
Declaration of conformity	30
Notes	31

User Guide

Congratulations! You are now in possession of a MDG **Me1** Fog Generator.

We hope this **Me1** Fog Generator will bring you long hours of satisfaction.

Please read the following instructions carefully and completely before filling your Fog Generator with the **MDG** Neutral Fog Fluid and turning it on.



CAUTION

This appliance is not intended for use by persons (including children) with reduced physical, sensory or mental capabilities, or lack of experience and knowledge, unless they have been given supervision or instruction concerning use of the appliance by a person responsible for their safety. Children should be supervised to ensure that they do not play with the appliance.



CAUTION

If the supply cord is damaged, it must be replaced by the manufacturer, its service agent or similarly qualified persons in order to avoid a hazard.

HOW TO READ THIS USER GUIDE



WARNING and **CAUTION** are used throughout this manual to forewarn of possible danger to the users if precautions are not observed. As is customary in military and some commercial manuals, the precautions will always precede the steps to which it refers so that the users will be aware of any potential danger before performing the task.



WARNING and **CAUTION** labels are key equipment parts. Do not remove, change or cover these labels. If the labels are not readable, contact **MDG FOG GENERATORS LTD.**

BOLD TEXT: Contains important information, cautionary steps and warnings that should be read and understood prior to installing the unit.

BOLD and ITALIC TEXT: pertains to product names and trademarks, proprietary names and products made by MDG FOG GENERATORS LTD.

Please read the following instructions carefully and completely before installing, pressurizing and turning on the Fog Generator.

QUALIFIED PERSONNEL

MDG Fog Generators Ltd systems will perform as designed but are to be installed, operated, and serviced by trained personnel. Installation, operation and servicing of this equipment require trained personnel with technical skills in electrical theory and fluid dynamics. This manual is not a substitute for qualified technicians or local authorities on electricity, gas, fluid, or engineering, and therefore does not supersede, amend or void local safety installation practices. Please refer to local authorities for further information.

NEED A LITTLE HELP?

At MDG, we try our best to provide you with complete information for our products. Despite our best efforts, sometimes, a little more is required due to the specifics of your project and installation. We're looking forward to go that extra mile for you.

Contact us:

By Phone: +1-800-663-3020 +1-514-272-6040

By Fax: +1-514-722-3229

By e-mail: info@mdgfog.com

On the Web: www.mdgfog.com

The QR code on the control panel is linked to the documentation of the Me1 from our web site.



Do not hesitate to follow the URL (just click on the QR Code).

By Mail: **MDG Fog Generators Ltd.**
10301, Avenue Pelletier
Montréal, QC, H1H 3R2
Canada

Please note that our business hours are from **08h00 to 12h00** and from **12h30 to 17h00** (8:00AM to 12:00PM and 12:30PM 5:00PM), **Eastern (GMT -5)**.

COPYRIGHT NOTICE

This User's Guide (Original Instructions) is copyrighted and all rights are reserved by MDG Fog Generators Ltd.

No part of this publication may be reproduced, transmitted, transcribed, stored in a retrieval system, or translated into any language or computer language, in any form or by any means, electronic, mechanical, magnetic, optical, chemical, manual or otherwise, without the prior written permission of MDG Fog Generators Ltd.

Basic description

The **Me1 Fog Generator** was designed with safety and reliability in mind. It is capable of generating pure white, non-toxic fog for as long as you have fluid (100% duty cycle). This generator is also equipped, as a standard feature, with the **Automatic Purging System™ (APS™)**. This system purges the heating module after the first heating cycle and after every emission of fog preventing residual build up and clogging.

The **Me1** is a variable output Fog Generator capable of generating large volumes of very dense fog in a short period of time. It is one of the quietest units on the market.

At the heart of the **MDG Me1** is an electronic assembly that keeps the heat exchanger at a very stable temperature, with three different types of fail-safe systems. Those three types of electronic fail-safe systems are designed to protect against over and under-heating conditions and against component failure. When an overheating condition is detected, or if the internal temperature of the generator reaches 60°C (140°F), a safety circuit is triggered. This circuit removes the power to the heating elements, preventing hazardous conditions. When an under-heating condition occurs, the generator will stop producing fog until the temperature of the heating module is back within parameters.

A fourth safety system consists of a pressure relief valve which limits the working pressure and protects against over-pressure.

The temperature of the heat exchanger is maintained within a narrow margin. If an error occurs (see **FAIL State**), the Fog Generator will automatically shut down. When one of the safety systems is activated, the Fail state will be displayed on the LCD, in the Status Menu. Check the **FAIL State** and **Troubleshooting** paragraphs for diagnostics, then shut down the main power switch, wait 30 seconds, and then switch the generator back on. If the failure persists, send your generator back to an authorized service center for verification.

When « Fog On » mode is activated (DMX or Control Menu), the MDG **Me1 Generator** will produce fog for as long as the ready level is reached (temperature) and all other control parameters are within specifications.

When « Fog On » mode is deactivated, the **APS™** cycle is automatically initiated to clear the heating module. Never remove the power to a generator while it is producing fog – See the **Shut down procedure**.



WARNING

- When not in use **ALWAYS** switch off the power switch located on the back panel, and **disconnect both gas and AC line**.
- **Never install above people.**
- This **Me1 Fog Generator** must be installed in an upright position on a stable and leveled surface.
- Use in a well-ventilated area.
- Do not operate at less than 2 meters (6.5 ft.) from people.

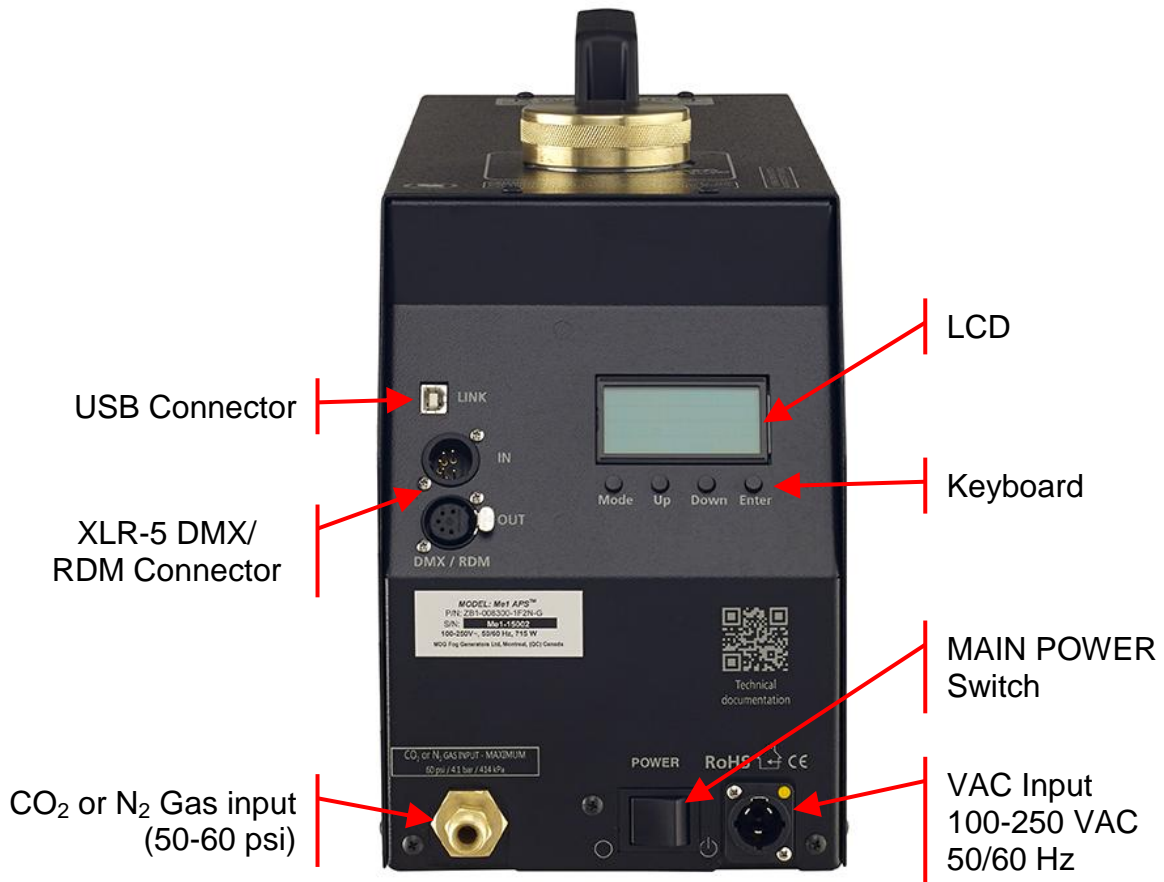

Installing the Me1

Exercise caution when selecting the location to install or use this equipment:

- Install the MDG **Me1** away from rain, wind, heavy dust or any harsh environment situations.
- Ensure available space for all electrical cable and gas tubing runs,
- The MDG **Me1** requires 2 m (6.56 ft) of clearance to the front.

Fill the reservoir with **MDG Neutral Fog Fluid** (see **Filling the Fluid Reservoir** paragraph).

Connect the gas inlet to a gas bottle equipped with a single or double stage regulator. The gas inlet is an Oxygen Adaptor (9/16-18 R.H).

Connect the data wiring (Male XLR-5 connector for DMX/RDM) if you are using a DMX or RDM controller.

Plug the PowerCON connector.

Connect the power cord 100-250 VAC, 50-60 Hz, 715W.

Open the gas bottle, and set the pressure between 50 and 60 psi (3.5 and 4.1 bar, or 350 and 410 kPa).

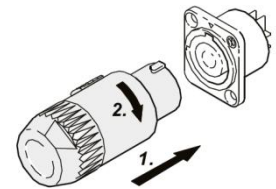

Working with the Me1

The MDG **Me1 Fog Generator** is quite easy to operate and requires no preventive maintenance.

Switch On the power.

The MDG **Me1** will display during four (4) seconds, the following message:

**Me1, by
MDG Fog Generators
Testing BootLoad....**

These four seconds allow you to connect the generator to your PC, via a USB cable, to update the firmware of the control board (see *BootLoader* for further details).

Then, the MDG **Me1** will display during one (1) second, the following message:

**Me1
by
MDG Fog Generators Ltd
(V: x.xx – F: y.yyy)**

where 'x.xx' is the version of your generator, and 'y.yyy' is the firmware of the program.

The program will load the configuration parameters saved in the EEPROM memory.

Finally, the screen will display the menu.

THE KEYBOARD

The user can scroll in the menu by using the buttons of the keyboard:

'Down' moves the selection to the next menu, or decrease a data value.

- When at the end of a list, the program moves back to the first item of this list.
- If the selected menu is a **data input menu**, keeping this key pressed will decrease the value more rapidly.
- In a **data input menu**, when the value reaches its minimum value, the program continues with the maximum value.

'Up' moves the selection to the previous menu, or increase a data value.

- If the item is the first of a menu, the program moves the selection to the last item of that menu.
- If the selected menu is a **data input menu**, keeping this key pressed will increase the value more rapidly.
- In a **data input menu**, when the value reaches its maximum value, the program continues with the minimum value.

'Mode' moves the last selection to the upper level

- This key has no effect in the first level.
- In a **data input menu**, pressing this key allows to exit the menu without changing any value (escape).

'Enter' confirms a selection or data value.

- This key has the same effect that the key '→', when scrolling through the menus.
- In a **toggle menu**, this key confirms the selection and moves the cursor back to the upper level menu.
- In a **data input menu**, this key confirms the value of the data and moves the cursor back to the upper level menu.

LCD SAVER

The program can automatically switch off the LCD screen (menu display and backlight) if there is no keyboard activity. The user can choose between a 30 second and a 2 minute delay in the **Settings Menu** (« SETTINGS ▶ LCD SAVER »).

When the LCD Saver is activated, just press any key of the keyboard to re-activate the LCD screen functions.

The user can also deactivate the LCD saver by selecting the OFF option.

MENU TREE



The menu is divided in four (4) main menus:

- **Status Menu** summarizes all the state of the fog generator. None of its sub menus can be modified.
- **Control Menu** allows the user to control locally the **MDG Me1**. All its sub menus can be set, as long as the generator is not in DMX/RDM mode.
- **Interface Menu** allows the user to define or verify the communication via DMX/RDM and change the personality of the generator.
- **Settings Menu** summarizes general configuration of the generator.

The menu is refreshed every second.

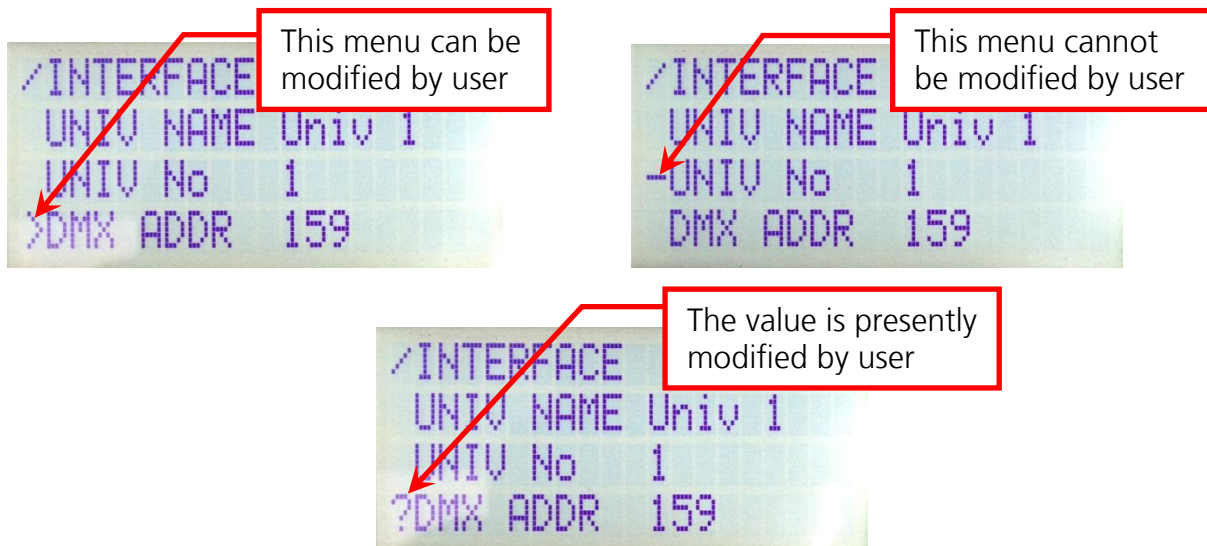
- Items preceded by the « - » character are state messages or parameters, updated by the program. The user cannot modify them.
- Items preceded by the « > » character are control parameters.
- The user, within specific ranges or choices, can **MODIFY** them. In user input mode, the value or the choice is preceded with the « ? » character.



The tree menu architecture is explained below. Items highlighted in blue are state menu (), and those highlighted in yellow are control menu ().

STATUS

Status menu

STATE

UNIT OFF
xx% HEAT
PURGE
READY
FOG ON
FAIL

Status **State**

- the generator is **off**
- the generator is **heating**, but not ready
- the generator is **purging** the heating module
- the generator is generator is **ready** to produce fog
- the generator is producing **Fog**
- the generator is off, due to a **failure** (see diagnostic)

ERROR

Error message when **State = FAIL** (see diagnostic)

TEMP.

TOO LOW
OK
TOO HIGH

Temperature status (heating module)

- temperature **too low**
- temperature within specifications (**ready**)
- temperature **too high**

PRESSURE

xx.x

Current reservoir **pressure**

PCB TEMP

Temperature of the board (see Units)

RUN TIME

xx.x

Total Run Time in decimal hours

FOG TIME

xx.x

Total Fog Time in decimal hours

LAST ERR

yyyyy

Code for the Last five (5) errors

See **Fail State** paragraph

CONTROL

Control menu

UNIT

OFF
ON

Unit toggle

- the generator is **off**
- the generator is **on**

FOG

OFF
ON

Fog toggle

- the fog is **off**
- the fog is **on**

«Me1» PERSONALITY

SET PRES.

xx.x

Fog operating **pressure** (see Units)

INTERFACE

COMM. -----

AUTO

LOCAL

DMX

DEV LABEL yyyyyy

DEV ID yyyyyy

DMX ADDR yy

PERSO. -----

Me1

MAX 3000

1 UNIT yy

«Me1» PERSONALITY

2 OUTPUT yy

3 FOG yy

«MAX 3000» PERSONALITY

2 FOG yy

SETTINGS

UNITS -----

PSI/°C

kPA/°C

BAR/°C

PSI/°F

LCD SAVER -----

30 s

2 mn

OFF

VERSION x.xx

FIRMWARE x.xx

Network /DMX/RDM Menu

Communication toggle

- the generator is controlled by **DMX/RDM** if a signal is present, or **locally** if there is no signal

- the generator is controlled by the **keyboard ONLY**

- the generator is controlled by **DMX/RDM ONLY**

RDM Device Name

RDM Device ID

DMX Address (1 to 510) Network / DMX / RDM

Personality toggle

- output is controlled via program

- output is set via the regulator pressure

Channel #1 value: OFF ≤ 50% (128) < ON

Channel #2 value: 0% (0) to 100% (255)

Channel #3 value: OFF ≤ 50% (128) < ON

Channel #2 value: OFF ≤ 50% (128) < ON

Settings menu

Units toggle

- pressure in **psi**, temperature in **Celsius**

- pressure in **kPa**, temperature in **Celsius**

- pressure in **bar**, temperature in **Celsius**

- pressure in **psi**, temperature in **Fahrenheit**

LCD Saver Mode

- LCD saver is activated after 30 s

- LCD saver is activated after 2 min

- LCD Saver is Off

Model Version

Program Firmware

OPERATING INSTRUCTIONS

The MDG **Me1 Fog Generator** can be controlled either locally, with the keyboard, via DMX (see *DMX control and RDM Control*). This paragraph focuses on **local control**.

Starting Procedures

When powering up the generator, the control program configures the Input/Output, and loads the configuration parameters saved in the EEPROM memory.

At this point, the MDG **Me1** switches to stand-by mode, and most of the electronic controls are off.

When the generator is manually switched to **«UNIT ON»** mode («CONTROL ▶ UNIT ▶ ON»), the program starts the heating cycle («STATUS ▶ STATE = % HEAT»), which will last approximately 7 to 8 minutes.

When the temperature reaches READY level («STATUS ▶ STATE = READY»), the Automatic Purging System™ (APSTM) will be initiated («STATUS ▶ STATE = PURGING»).

After the first purging cycle is completed (approx. time 30 sec.) the generator is ready to produce fog.

Fog Production

When the generator is manually switched to **«FOG ON»** mode («CONTROL ▶ FOG ▶ ON»), the **Me1** will start producing fog.

The amount of the fog emission can be controlled by adjusting the pressure («CONTROL ▶ PRESSURE ▶ XX») from 2 psi to 40 psi.

The MDG **Me1** will produce fog as long as the control parameters are within specifications, and the fog fluid reservoir filled.

If a critical problem occurs, the program shuts down automatically the fog generator, and displays an error message in the **State Menu** (see *Fail State*) and the LCD will flash.

When the generator is manually switched to **«FOG OFF»** mode («CONTROL ▶ FOG ▶ OFF»), the **Me1** will stop producing haze and initiate the automatic purging cycle.



WARNING

Never power off a generator while it is producing fog – See the shut down procedure.

Shut down procedure

Never shut down the MDG **Me1** while making Fog.

Power off the generator observing the following sequence:

- **Turn off** the fog emission,
- Wait 30 seconds for the **APS™** cycle to complete,
- Switch the generator **«UNIT OFF»** mode («CONTROL ▶ UNIT ▶ OFF»),
- Power off the MDG **Me1**, by switching off the “MAIN POWER SWITCH”.

Switching directly the generator in **«UNIT OFF»** mode by DMX/RDM will yield the same result as above. Wait for all the cycles to complete before powering off the generator.

FAIL State

FAIL state mode is initiated if any critical error occurs.

In this state, the MDG **Me1** is **off**, awaiting an action from the user.

A critical error is always displayed in the **Status Menu** («STATUS ▶ ERROR»), as well as the five (5) last critical errors («STATUS ▶ LAST ERR»),

- **ERROR = HEATER** **LAST ERR CODE = 6**

This error will occur if the temperature of the heating module is not increasing with the proper thermal ramp.

This is generally due to a heater cartridge(s) problem. Shut down the generator and restart it. Check the heating process with the value of the Status («STATUS ▶ STATE ▶ xx% HEAT»). If the percent is not increasing, the heater cartridges have failed.

- **ERROR = P. LOW** **LAST ERR CODE = 7**

This error will occur if the generator is unable to reach the operating pressure within a fixed time interval.

This may be due to a leaking gas line (between the gas bottle and the generator), a closed or empty gas bottle, the set pressure of the regulator below 50-60 psi (3.5-4.1 bar, or 350-410 kPa), a ball valve closed on the gas line or a problem with the pressure transducer.

With CO₂ bottles, too much output or siphon configuration may also cause the regulator freezes.

- **ERROR = P. HIGH** **LAST ERR CODE = 8**

This error will occur if the pressure is too high for a specific regime, while the gas flow inlet is fully closed.

This may be due to a solenoid valve malfunction (electronic or physical blockage), a problem with the pressure transducer, the heating module partially clogged or the use of cryogenic (liquid) gas.

- **ERROR = T. HIGH** **LAST ERR CODE = 4**

This error will occur if the temperature of the heating module is too high.

This is generally due to an electronic problem. Shut down the generator and restart it.

- **ERROR = T. SAF** **LAST ERR CODE = 5**

This error will occur if abnormal temperature difference between the two sensors of the heating module is detected.

This is generally due to an electronic or a sensor problem. Shut down the generator and restart it.

- **ERROR = PCB HIGH** **LAST ERR CODE = D**

This error will occur when the internal temperature of the generator is too high.

This may happen if the external temperature is high. Move the generator in the shade or to a cooler location. Shut down, wait few minutes, and then restart the generator.

- **ERROR = WD RST** **LAST ERR CODE = E**

This error will occur if the watchdog (software safety) resets the generator.

This is generally due to software error, an interference or chip problem. Shut down the generator and restart it.

Please contact an Authorized Service Center if any problem persists.

DMX CONTROL

The MDG **Me1** can be controlled via a DMX512-A USITT standard protocol.



WARNING

Activating the «**DMX**» mode («**INTERFACE ▶ MODE ▶ DMX**»), controls the MDG Me1 only by DMX signal. If the DMX wire is **unplugged** or DMX **signal is lost**, the generator **initiates an automatic shutdown procedure**.

Activating the «**AUTO**» mode («**INTERFACE ▶ MODE ▶ AUTO**»), controls MDG Me1 by DMX, only if there is a signal. If the DMX wire is **unplugged** or DMX **signal is lost**, the generator **keeps the last DMX values**.



WARNING

In «**AUTO Mode**», DMX commands always take precedence over Local commands.

The MDG **Me1** provides a simple way to check if there is DMX signal:

```

/INTERFACE 18:30:01
>COMM.     AUTO
DEV LABEL ONE-14100
DEV ID     1
    
```

No DMX Signal

```

/INTERFACE .18:30:33
>COMM.     AUTO
DEV LABEL ONE-14100
DEV ID     1
    
```

DMX Signal

The user can change the DMX Start Address in the Interface Menu («DMX Add»), and choose any value between 1 and 510 (512, last DMX channel).

The generator uses two (2) or three (3) DMX channels, depending on its personality:

Personality Me1

- Channel 1 **0 (0%)** < UNIT OFF ≤ **128 (50%)** < UNIT ON ≤ **255 (100%)**
- Channel 2 **0 (0%) – 255 (100%)**, FOG OUTPUT (from minimum to maximum)
- Channel 3 **0 (0%)** < FOG OFF ≤ **128 (50%)** < FOG ON ≤ **255 (100%)**

Personality MAX 3000

- Channel 1 **0 (0%)** < UNIT OFF ≤ **128 (50%)** < UNIT ON ≤ **255 (100%)**
- Channel 2 **0 (0%)** < FOG OFF ≤ **128 (50%)** < FOG ON ≤ **255 (100%)**

These channels have the same behaviour that the menus of the local interface (see **Operating instructions** paragraph).

BOOTLOADER

The MDG **Me1** uses a BootLoader, also called boot manager. This program is a firmware (software embedded in a hardware device) located into the non-volatile memory of the microcontroller unit (MCU) that allows in-circuit reprogramming of the device using its USB communication port.

To upgrade the firmware, you will need:

- a computer running under Windows, with a USB 2.0 connector
- special driver for the USB, included in the package,
- a standard USB 2.0 cable, A to B Male/Male type

Contact the MDG Service to have the last package firmware upgrade for the MDG **Me1**.

RDM CONTROL

The MDG **Me1** can be controlled via a RDM ANSI E1.20 protocol, an intelligent bi-directional communication utilizing the DMX512 data link.

RDM allows a console or other controlling device to discover and then configure, monitor, and manage intermediate and end-devices connected through a DMX512 network. RDM provides for intelligent control of devices on a DMX512 network, which has not been previously available outside of proprietary networks

RDM Control has the same functionalities than the DMX Control (see *DMX Control*) with bi-directional functions allowing the user to read or write specific functions.

The RDM supported parameters implemented in the MDG **Me1 Fog Generator** are summarized in the following table.

RDM Parameter ID's	Value	GET Allowed	SET Allowed	Comments
DISC_UNIQUE_BRANCH	0x0001			
DISC_MUTE	0x0002			
DISC_UN_MUTE	0x0003			
QUEUED_MESSAGE	0x0020	✓		
STATUS_MESSAGES	0x0030	✓		
SUPPORTED_PARAMETERS	0x0050	✓		
PARAMETER_DESCRIPTION	0x0051	✓		
DEVICE_INFO	0x0060	✓		
PRODUCT_DETAIL_ID_LIST	0x0070	✓		
DEVICE_MODEL_DESCRIPTION	0x0080	✓		White Mineral oil hazer
MANUFACTURER_LABEL	0x0081	✓		MDG Fog Generators Ltd
DEVICE_LABEL	0x0082	✓	✓	
SOFTWARE_VERSION_LABEL	0x00C0	✓		
DMX_PERSONALITY	0x00E0	✓	✓	2
DMX_PERSONALITY_DESCRIPTION	0x00E1	✓		
DMX_START_ADDRESS	0x00F0	✓	✓	1 to 510
SLOT_INFO	0x0120	✓		
SLOT_DESCRIPTION	0x0121	✓		
DEFAULT_SLOT_VALUE	0x0122	✓		
IDENTIFY_DEVICE	0x1000	✓	✓	LCD flashes
MDG_GENERATOR_STATE	0x8002	✓		ASCII text (Up to 20 characters)
MDG_LCD_SAVER	0x8004	✓	✓	Unsigned Byte (0=30 s, 1=2 min, 2=Off)
MDG_COM	0x8005	✓	✓	Unsigned Byte (0=AUTO, 1=LOCAL, 2=DMX)

Table 1: RDM Supported Parameters.

Fog Fluid

Operate **the Me1 Fog generator** only with the **MDG Neutral Fog Fluid**.

Make sure that no other liquids or particles are mixed or added to the **MDG Fog Fluid**.

The **MDG Neutral Fog Fluid** produces a pure, white, non-toxic fog.

MDG Neutral Fog Fluid is available at authorized MDG distributors or dealers.

Available in 4 L (1 US gallon), 5 L (Europe Only), 20 L (5.3 US gallon), 205 L (55 US gallon) and 1000 L (264 US gallon).



FILLING THE FLUID RESERVOIR



WARNING

Use only **MDG Neutral Fog Fluid**. Not doing so will void the warranty and may damage the generator.



CAUTION

DISCONNECT UNIT BEFORE ADDING FOG FLUID.

To fill the fluid reservoir, unscrew the brass cap and pour the **MDG Neutral Fog Fluid** until it reaches the inside bottom of the opening.

Avoid overfilling, screw back the brass cap and make sure it is tightened.

Troubleshooting

Contact MDG if symptoms are not listed, or if the provided solutions fail to resolve the issue.

Table 2: Symptoms and Solutions

Symptoms	Probable Causes and Suggested Actions
The fog generator does not switch on	<ul style="list-style-type: none"> • Verify that AC power cord is properly connected on both ends. • Check the fuse or the breakers of your VAC entry. The wattage of the generator is around 715 W. • Verify the AC voltage on the power cord. 100~250 VAC.
The generator does not produce fog	<ul style="list-style-type: none"> • Verify that the Unit is ON «CONTROL ▶ UNIT ▶ ON» • Verify that the UNIT is READY «STATUS ▶ STATE = READY» <p>The generator requires approximately seven to eight (7 to 8) minutes to be ready. While the heating module is warming up, the % HEAT must vary.</p> <ul style="list-style-type: none"> • Verify that the Unit is not in a FAIL state «STATUS ▶ STATE = FAIL» <p>If so, check the symptoms below</p> <ul style="list-style-type: none"> • Verify the communication mode. «INTERFACE ▶ MODE» <p>You cannot control the generator locally if you are in DMX mode, and vice-versa.</p> <ul style="list-style-type: none"> • If you are in DMX mode: <ul style="list-style-type: none"> • Verify the cable • Verify the DMX Start address and the patch
	.../...

Symptoms	Probable Causes and Suggested Actions
<p>« STATE = FAIL» VERIFY THE ERROR MESSAGES</p>	<ul style="list-style-type: none"> • ERROR = P. LOW <ul style="list-style-type: none"> • Open the gas bottle • With CO₂ bottle, verify the regulator is not frozen • Verify the set pressure on the regulator (50-60 psi, 3.4-4.1 bar or 340-410 kPa) • Verify the gas line • Verify the reading of the pressure transducer «STATUS ▶ PRESSURE» • ERROR = P. HIGH <ul style="list-style-type: none"> • Verify the reading of the pressure transducer «STATUS ▶ PRESSURE» • Verify you are not using a Siphon CO₂ bottle • You may have a solenoid valve malfunction. Restart the generator. <p>Please contact MDG Service if this problem persists.</p> • ERROR = HEATER <ul style="list-style-type: none"> • This is a heating timeout, due to a cartridge heater problem. • Restart the generator and check the heating status «STATUS ▶ STATE = xx% HEAT». If the heating value is not progressing, there may be various issues. • Check the fuses on the heater board <p>Contact MDG Service.</p> • ERROR = T. HIGH <ul style="list-style-type: none"> • Restart the generator. This is generally due to an electronic problem. <p>Please contact MDG Service if this problem persists.</p> • ERROR = T. SAF <ul style="list-style-type: none"> • Restart the generator. This is generally due to an electronic or sensor problem. <p>Please contact MDG Service if this problem persists.</p>
	<p>.../...</p>

Symptoms	Probable Causes and Suggested Actions
	<ul style="list-style-type: none"> • ERROR = PCB HIGH <ul style="list-style-type: none"> • Stop the generator for a few minutes, if it is possible • Try to change the position of the generator to a cooler location. <p>Please contact MDG Service if this problem persists.</p> • ERROR = WD RESET <ul style="list-style-type: none"> • Restart the generator. <p>Please contact MDG Service if this problem persists.</p>
<p>LCD displays strange letters or does not seem to work normally</p>	<p>In some conditions (Radio transmission or static discharges), the LCD may lose its settings. The generator is still working, but the LCD displays strange or no characters:</p> <ul style="list-style-type: none"> • Wait 30 seconds without touching any key, until the LCD saver starts • Press any key <p>If the menu does not reappear, restart the generator.</p> <p>Please contact the Service if this problem persists.</p>

Accessories

FLIGHT CASE

Whether by plane, train or automobile, make sure your fog generator travels safe. Our sturdy flight cases have high-quality padding to make the journey easier on your generator, with special compartments for accessories like cable extensions and remote control timers.



PORTABILITY OPTION

The portability option stores the gas canister securely underneath your generator. Special technology allows the canister to operate horizontally without the gas line freezing.

Just pick up your machine and go – no more dragging around the canister, and no more worrying about it tipping over.



Cable Requirements

CONNECTION TO THE MAIN

If the supply cord is damaged, it must be replaced by a special cord or assembly available from the manufacturer, or its distributing / service agent.

- Operating voltage: 100-250 VAC, single phase. 50/60 Hz, 715 W.
- Ground / Earth connection **REQUIRED**.
- Cable: 2 mm² (14 AWG), 3-wire, 105 °C copper, 300 V
CE UL/CSA compliant cable
- Cable Preparation: Da = 9.5 [0.374"] - 15.0 [0.59"]



- Cable Assembly

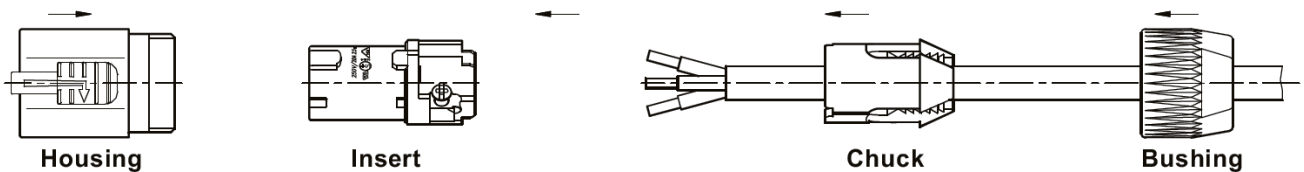

1. Put bushing and chuck onto the cable
2. Prepare cable as shown above
3. Insert the wire into the terminals and fasten the clamping device by a flat screw driver
4. Push insert and chuck into housing (pay attention to the guiding keyway!)
5. Fasten bushing by means of a fork wrench ¾", min. Torque 2.5 Nm (1.8 lb-ft)

DMX 512 CONNECTION

- DMX/RDM data: Dual twisted pair 0.75 mm (22 AWG) + shield, XLR-5 type connector, CE UL/CSA compliant cable.
- Wiring XLR Connectors :

1 – Shield	3 - Signal (+)	5 – Not connected
2 - Signal (-)	4 – Not connected	

Technical specifications

Series	MAX ^{APS} Series
Maximum fog output (per minute):	100 m ³ (3,531 ft ³)
Fog colour:	Pure white
Particle size:	0.5 to 0.7 microns
Fluid consumption:	1.0 L (30 oz / 0.26 US gal) per hour at 2.76 bar / 40 psi
Fluid type:	MDG Neutral TM Fog Fluid ONLY M.S.D.S. available on request
Fluid reservoir:	2.5 L (0.66 US gal) bottle
Gas type:	Industrial Grade CO ₂ or N ₂
Gas pressure input:	4.15 bar / 60 psi max
Gas consumption:	1.0 kg (2.2 lb) per hour at 2.76 bar / 40 psi
Automatic Purging System TM :	Standard feature
Warm-up time:	8 minutes
Operating voltage:	100-250 VAC, 50/60Hz, 1 phase Ground / Earth connection REQUIRED
Power consumption:	715 W
Control signal:	Manual (4 buttons keyboard + LCD) USB (diagnostic & Bootload) DMX / RDM Protocol
Operating temperature:	0 °C to 50 °C (32 °F to 122 °F)
Operating humidity:	90 % relative humidity @ 50 °C (122 °F), non-condensing
Storage temperature:	-40 °C (-40 °F) to 60 °C (140 °F)
Storage humidity:	80% relative humidity @ 60 °C (140 °F)
Approval	CE, CSA and UL pending
Dimensions	30 cm (12") H x 18 cm (7") W x 61 cm (24") L
Weight:	16 kg (35 lb)
Shipping Weight:	20 kg (44 lb) without flight case 29 kg (64 lb) with flight case

Dimensions

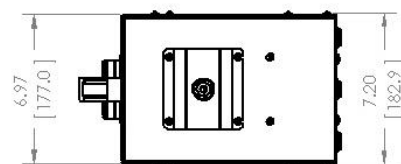
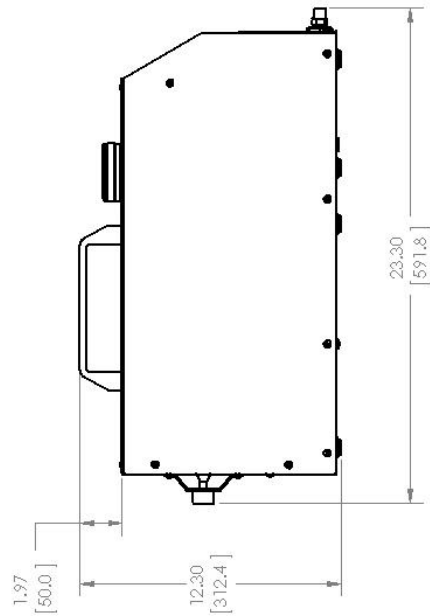
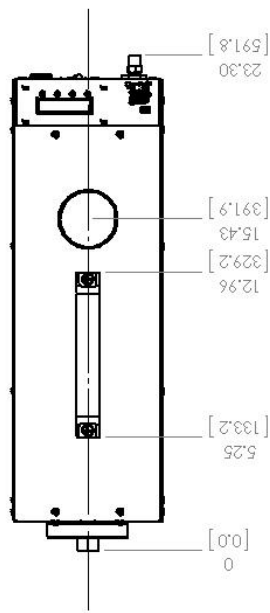
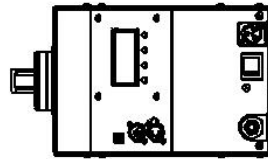

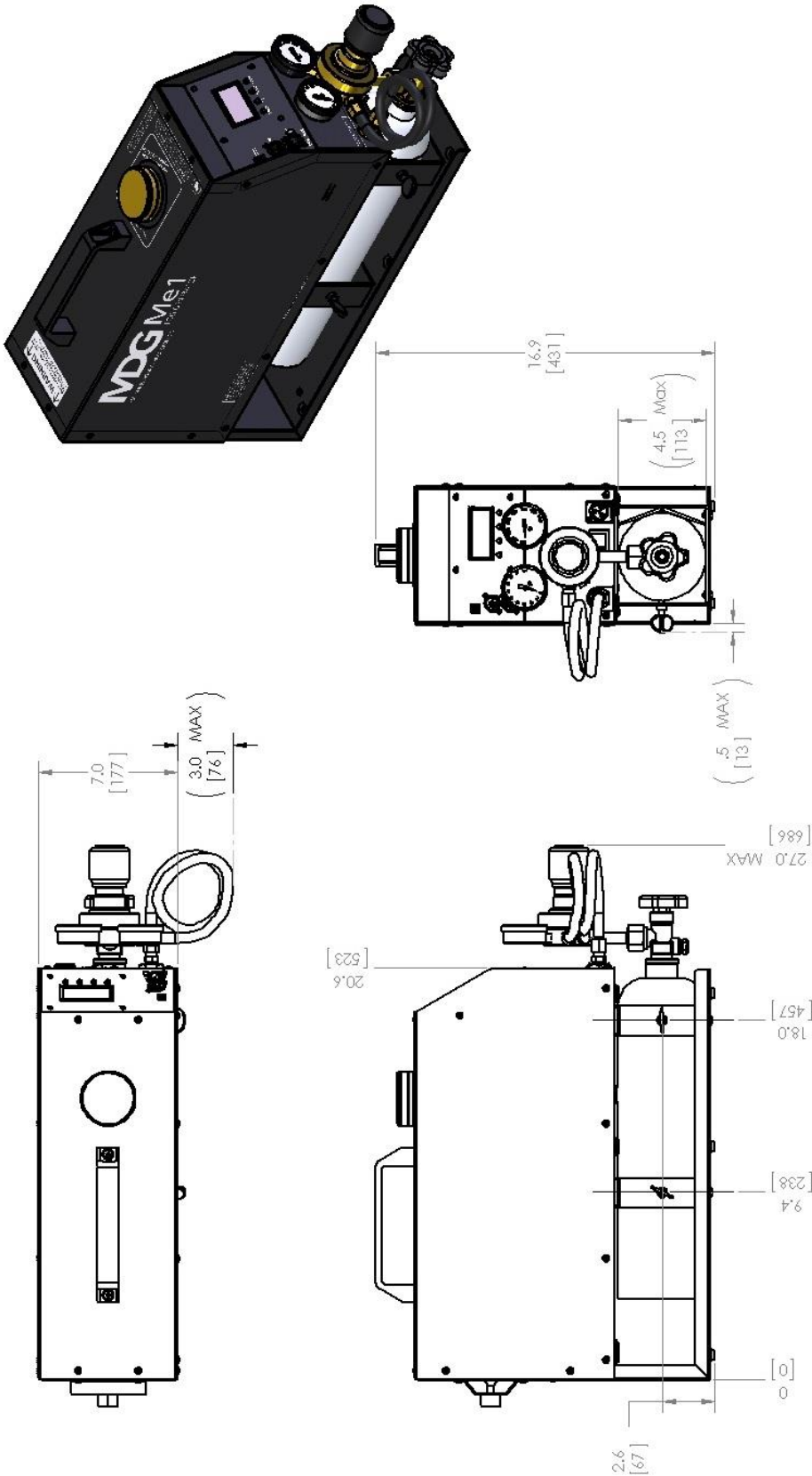

Warranty

When installed and operated as recommended, **MDG Fog Generators Ltd** guarantees that this product will remain free of defects in parts and labour for a period of two (2) years from the moment it is delivered. This warranty does not apply if the product has been modified without our written authorization, or repaired without a written authorization from MDG or one of its authorized service centres, or if it is used under conditions for which it has not been designed, or if any other fluid than the **MDG Neutral Fog Fluids** has been used. **MDG Fog Generators Ltd** is not responsible for any damages resulting from a faulty installation or from abusive use of the product.

If any device is found unsatisfactory under the terms of this warranty, **MDG Fog Generators Ltd** will repair or replace it free of all charges, except transportation costs.

This warranty applies only to the product itself and **MDG Fog Generators Ltd** declines responsibility for any losses, costs, or damages resulting from its use.

MDG Fog Generators Ltd shall not be liable for consequential damage in case of any failure to meet the conditions of any warranty or shipping schedule, nor will claims for labour, loss of profits, repairs, or other expenses incidental to replacement be allowed.

The repair or replacement of the product, by **MDG Fog Generators Ltd** shall constitute fulfilment of all obligations to the purchaser.

No other guarantees or warranties, expressed or implied, are made by **MDG Fog Generators Ltd** in connection with its products. This warranty is non-transferable and applies to the original purchaser only.

To obtain satisfaction under the terms of this warranty, contact your local sales office, and we will be pleased to help you.

Declaration of conformity



EC DECLARATION OF CONFORMITY

According to IEC/ISO 17050

We, **MDG Fog Generators Ltd**
10301 ave Pelletier
Montreal, QC, Canada, H1H 3R2

declare under our sole responsibility, that the product including options or accessories

Fog Generators models: Me1, Me2, Me4 and Me8,
MAX 3000 APS, MAX 5000 APS and MAX 5000 APS H.O.
ATMe, ATMOSPHERE APS and ATMOSPHERE APS H.O.
ICE FOG Q and ICE FOG Compack
MM, MINI SINGLE, SINGLE and DUAL

to which this declaration relates, is in conformity with the following standards:

IEC 60335-1: 2001 (Fourth Edition) incl. Corr.1:2002 + A1:2004 + A2:2006
Household and similar electrical appliances – Safety/Part 1, September 2006
CISPR 22:2008-09/EN 55022, Class B
IEC 61000-6-1:2005/EN61000-6-1:2007, (EMC)-Part 6-1
FCC PART 15, Subpart B, class B

By conformance with the standards referenced, the product follows the provisions of the directives listed below:

2006/95/EC Low Voltage Directive
2004/108/EC EMC Directive
2011/65/EU RoHS2 Directive

Martin Michaud, President

August 17, 2012
Montreal, Canada

